

ITEM NO.	P/N	Description	QTY.
1	BPSQ	BACKPLATE	2
2	HKSQ-2.5	Neck	2
3	HBSQ-78	HUB	2
4	GLRT-16	GLASS	1
5	TU12-3	TUBE SUPPORT	2
6	TU12-18	BAR	1

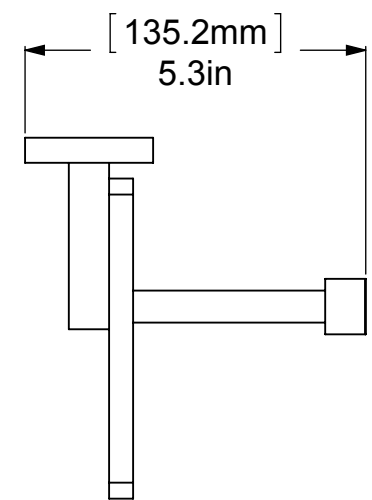
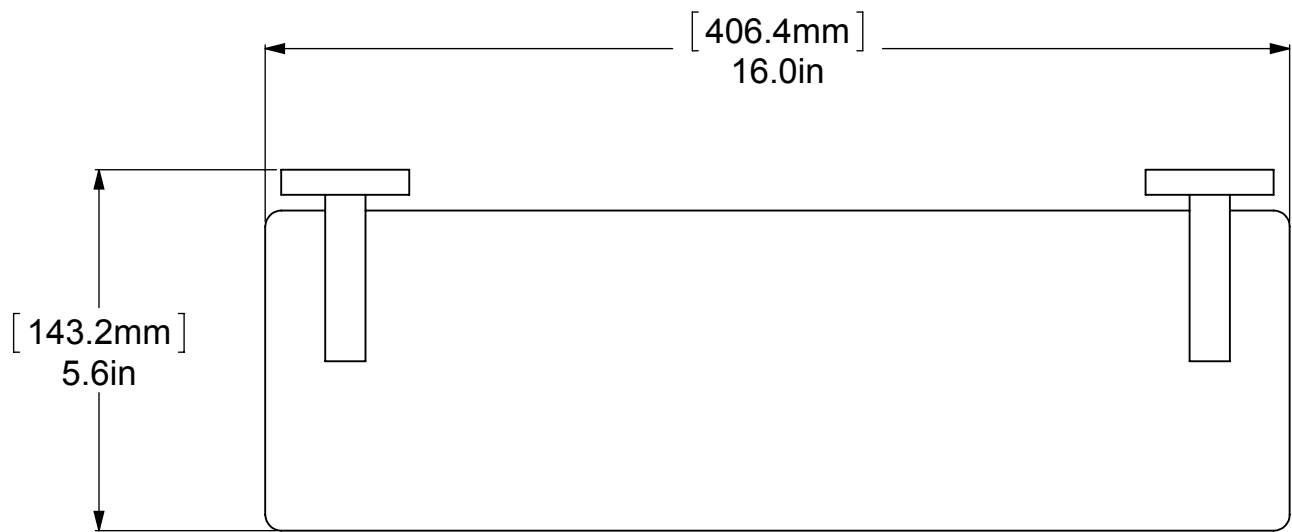
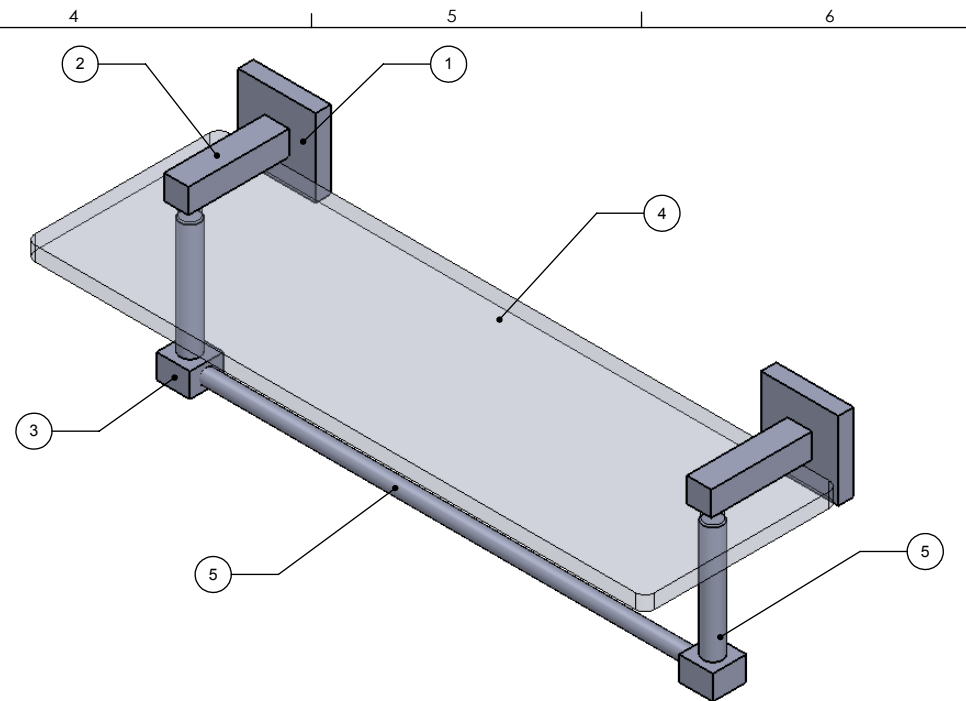

UNLESS OTHERWISE STATED

.X	±.3mm
.XX	±.15mm
.XXX	±.008mm

COPYRIGHT © Allied Brass 2016

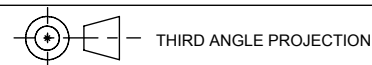

DRAWN	4/30/2016	I.M
CHECKED	4/30/2016	P.D
APPROVED	4/30/2016	R.A

MATERIAL:	BRASS
DESCRIPTION:	SHELF WITH TOWEL BAR



FINISH	TBD
QUANTITY	TBD
DRAWING No.	REV
MT1-16TB	0
SCALE	1:3 SHEET: 01 A4